

Register your product and get support at  
[www.philips.com/welcome](http://www.philips.com/welcome)

AZ1850



---

EN User manual

---

**PHILIPS**

## 1 Important

---

### Safety

---

#### Important Safety Instructions

- ① Read these instructions.
- ② Keep these instructions.
- ③ Heed all warnings.
- ④ Follow all instructions.
- ⑤ Do not use this apparatus near water.
- ⑥ Clean only with dry cloth.
- ⑦ Do not block any ventilation openings. Install in accordance with the manufacturer's instructions.
- ⑧ Do not install near any heat sources such as radiators, heat registers, stoves, or other apparatus (including amplifiers) that produce heat.
- ⑨ Protect the power cord from being walked on or pinched, particularly at plugs, convenience receptacles, and the point where they exit from the apparatus.
- ⑩ Only use attachments/accessories specified by the manufacturer.
- ⑪ Use only with the cart, stand, tripod, bracket, or table specified by the manufacturer or sold with the apparatus. When a cart is used, use caution



when moving the cart/apparatus combination to avoid injury from tip-over.

- ⑫ Unplug this apparatus during lightning storms or when unused for long periods of time.
- ⑬ Refer all servicing to qualified service personnel. Servicing is required when the apparatus has been damaged in any way, such as power-supply cord or plug is damaged, liquid has been spilled or objects have fallen into the apparatus, the apparatus has been exposed to rain or moisture, does not operate normally, or has been dropped.
- ⑭ **Battery usage CAUTION – To prevent battery leakage which may result in bodily injury, property damage, or damage to the unit:**
  - Install all batteries correctly, + and - as marked on the unit.
  - Do not mix batteries (old and new or carbon and alkaline, etc.).
  - Remove batteries when the unit is not used for a long time.
  - The batteries shall not be exposed to excessive heat such as sunshine, fire or the like.
- ⑮ Apparatus shall not be exposed to dripping or splashing.
- ⑯ Do not place any sources of danger on the apparatus (e.g. liquid filled objects, lighted candles).
- ⑰ This product may contain lead and mercury. Disposal of these materials may be regulated due to environmental considerations. For disposal or recycling information, please contact your local authorities or the Electronic Industries Alliance: [www.eiae.org](http://www.eiae.org).

## Important notes for users in the U.K.

### Mains plug

This apparatus is fitted with an approved 13 Amp plug. To change a fuse in this type of plug proceed as follows:

- 1 Remove fuse cover and fuse.
- 2 Fix new fuse which should be a BS1362 3 Amp, A.S.T.A. or BSI approved type.
- 3 Refit the fuse cover.

If the fitted plug is not suitable for your socket outlets, it should be cut off and an appropriate plug fitted in its place.

If the mains plug contains a fuse, this should have a value of 3 Amp. If a plug without a fuse is used, the fuse at the distribution board should not be greater than 3 Amp.

*Note: The severed plug must be disposed of to avoid a possible shock hazard should it be inserted into a 13 Amp socket elsewhere.*

### How to connect a plug

The wires in the mains lead are coloured with the following code:  
blue = neutral (N), brown = live (L).

- o As these colours may not correspond with the colour markings identifying the terminals in your plug, proceed as follows:
  - Connect the blue wire to the terminal marked N or coloured black.
  - Connect the brown wire to the terminal marked L or coloured red.
  - Do not connect either wire to the earth terminal in the plug, marked E (or  $\frac{1}{2}$ ) or coloured green (or green and yellow).

Before replacing the plug cover, make certain that the cord grip is clamped over the sheath of the lead - not simply over the two wires.

### Copyright in the U.K.

Recording and playback of material may require consent. See Copyright Act 1956 and The Performer's Protection Acts 1958 to 1972.



## Warning

- Never remove the casing of this apparatus.
- Never lubricate any part of this apparatus.
- Never place this apparatus on other electrical equipment.
- Keep this apparatus away from direct sunlight, naked flames or heat.
- Never look into the laser beam inside this apparatus.
- Ensure that you always have easy access to the power cord, plug or adaptor to disconnect this apparatus from the power.

## Hearing Safety

### Listen at a moderate volume:

Using headphones at a high volume can impair your hearing. This product can produce sounds in decibel ranges that may cause hearing loss for a normal person, even for exposure less than a minute. The higher decibel ranges are offered for those that may have already experienced some hearing loss.

Sound can be deceiving. Over time your hearing 'comfort level' adapts to higher volumes of sound. So after prolonged listening, what sounds 'normal' can actually be loud and harmful to your hearing. To guard against this, set your volume to a safe level before your hearing adapts and leave it there.

To establish a safe volume level:

Set your volume control at a low setting.

Slowly increase the sound until you can hear it comfortably and clearly, without distortion.

Listen for reasonable periods of time:

Prolonged exposure to sound, even at normally 'safe' levels, can also cause hearing loss.

Be sure to use your equipment reasonably and take appropriate breaks.

Be sure to observe the following guidelines when using your headphones.

Listen at reasonable volumes for reasonable periods of time.

Be careful not to adjust the volume as your hearing adapts.

Do not turn up the volume so high that you can't hear what's around you.

You should use caution or temporarily discontinue use in potentially hazardous situations.

Do not use headphones while operating a motorized vehicle, cycling, skateboarding, etc.; it may create a traffic hazard and is illegal in many areas.

- Where the MAINS plug or an appliance coupler is used as the disconnect device, the disconnect device shall remain readily operable.



### Caution

- Use of controls or adjustments or performance of procedures other than herein may result in hazardous radiation exposure or other unsafe operation.

---

## Notice

This product complies with the radio interference requirements of the European Community.

This product complies with the requirements of the following directives and guidelines: 2004/108/EC + 2006/95/EC

Any changes or modifications made to this device that are not expressly approved by Philips Consumer Lifestyle may void the user's authority to operate the equipment.



## Recycling

Your product is designed and manufactured with high quality materials and components, which can be recycled and reused.



When you see the crossed-out wheel bin symbol attached to a product, it means the product is covered by the European Directive 2002/96/EC:



Never dispose of your product with other household waste. Please inform yourself about the local rules on the separate collection of electrical and electronic products. The correct disposal of your old product helps prevent potentially negative consequences on the environment and human health.

Your product contains batteries covered by the European Directive 2006/66/EC, which cannot be disposed of with normal household waste.

When you see the crossed-out wheel bin symbol with the chemical symbol 'Pb', it means that the batteries comply with the requirement set by the directive for lead:



Please inform yourself about the local rules on separate collection of batteries. The correct disposal of batteries helps prevent potentially negative consequences on the environment and human health.

Recording and playback of material might require consent. See Copyright Act 1956 and The Performer's Protection Acts 1958 to 1972.

## Environmental information

All unnecessary packaging has been omitted. We have tried to make the packaging easy to separate into three materials: cardboard (box), paper pulp (buffer) and polyethylene (bags, protective foam sheet.)

Your system consists of materials which can be recycled and reused if disassembled by a specialized company. Please observe the local regulations regarding the disposal of packaging materials, exhausted batteries and old equipment.

The making of unauthorized copies of copy-protected material, including computer programs, files, broadcasts and sound recordings, may be an infringement of copyrights and constitute a criminal offence. This equipment should not be used for such purposes.



Be responsible  
Respect copyrights

---

## Trademark notice

The USB-IF Logos are trademarks of Universal Serial Bus Implementers Forum, Inc.



Windows Media and the Windows logo are trademarks, or registered trademarks of Microsoft Corporation in the United States and/or other countries.



This apparatus includes this label:



## 2 Your CD Soundmachine

---

### Introduction

With this apparatus, you can enjoy music from audio discs, external devices, and listen to radio stations.



The apparatus offers you multiple sound effect settings that enrich sound with Digital Sound Control (DSC) and Dynamic Bass Boost (DBB). The apparatus supports the following media formats:



#### Note

- The type plate is located on the back of the apparatus.

---





## What's in the box

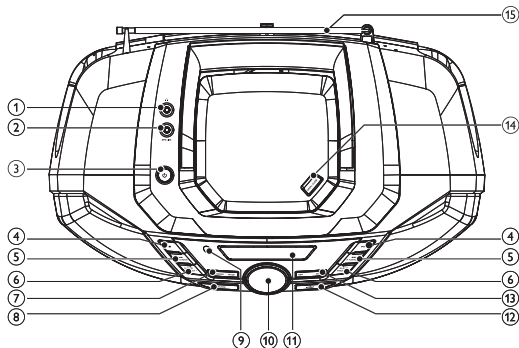

Check and identify the contents of the package:

- Main unit
- AC power cord
- Remote control
- User Manual
- Quick Start Guide

# Overview of the main unit





- ① 
  - Headphone socket.
- ② **MP3 LINK**
  - Jack for an external audio device.
- ③ 
  - Turn on/off the unit.
- ④ 
  - Stop play.
  - Erase a program.
- 
  - Start or pause play.

- ⑤  • Skip to the previous/next track.  
• Tune to a radio station.  
• Search within a track.
- ⑥ **ALBUM/PRESET -/+**  
• Select a preset radio station.  
• Skip to the previous/next album.
- ⑦ **PROGRAM**  
• Program tracks and browse the program.  
**MODE**  
• Select a play mode: REPEAT or SHUFFLE.
- ⑧ **SOURCE**  
• Select a source.
- ⑨ **IR**  
• Remote control sensor.
- ⑩ **- VOLUME +**  
• Adjust volume.
- ⑪ **Display panel**  
• Display current status.
- ⑫  • USB socket.
- ⑬ **DBB**  
• Turn on/off dynamic bass boost.  
**DSC**  
• Select a preset sound setting.
- ⑭ **OPEN•CLOSE**  
• Open/close the disc compartment.
- ⑮ **Antenna**

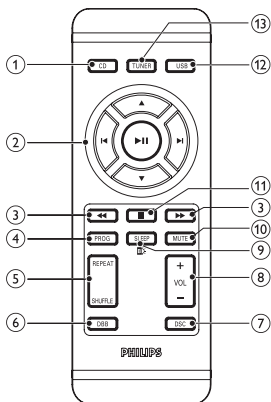
# Overview of the remote control



- ① **CD**
- Select disc source.
- ② **▲/▼**
- Skip to the previous/next album.
  - Select a preset radio station.
- ◀/▶**
- Skip to the previous/next track.
- ▶ ||**
- Start or pause play.
- ③ **◀◀▶▶**
- Search within a track.

- ④ **PROG**
- Program radio stations.
  - Program tracks.
- ⑤ **REPEAT**
- Select repeat play modes.
- SHUFFLE**
- Select shuffle play modes.
- ⑥ **DBB**
- Turn on/off dynamic bass boost.
- ⑦ **DSC**
- Select a preset sound setting.
- ⑧ **VOL +/-**
- Adjust volume.
- ⑨ **SLEEP **
- Set the sleep timer.
  - Turn on/off the screen backlight of main unit.
- ⑩ **MUTE**
- Mute or restore volume.
- ⑪ ****
- Stop play.
  - Erase a program.
- ⑫ **USB**
- Select USB source.
- ⑬ **TUNER**
- Select tuner source.

## 3 Get started



### Caution

- Use of controls or adjustments or performance of procedures other than herein may result in hazardous radiation exposure or other unsafe operation.

Always follow the instructions in this chapter in sequence.

If you contact Philips, you will be asked for the model and serial number of your apparatus. The model number and serial number are on the bottom of your apparatus. Write the numbers here:

Model No. \_\_\_\_\_

Serial No. \_\_\_\_\_

---

## Install batteries



### Note

- You can use both batteries and AC power as power supply of this apparatus.
- Batteries are not supplied with the accessories.

- 1 Open the battery compartment.
- 2 Insert 6 batteries (type: R-20, UM-1 or D-cells) with correct polarity (+/-) as indicated.
- 3 Close the battery compartment.

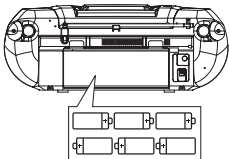

---

## Prepare the remote control



### Caution

- Risk of explosion! Keep batteries away from heat, sunshine or fire. Never discard batteries in fire.
- Risk of decreased battery life! Never mix different brands or types of batteries.
- Risk of product damage! When the remote control is not used for long periods, remove the batteries.

### For first-time use:

- 1 Remove the protective tab to activate the remote control batteries.

### To replace the remote control batteries:

- 1 Open the battery compartment.
- 2 Insert 1 CR2025 batterie with correct polarity (+/-) as indicated.
- 3 Close the battery compartment.

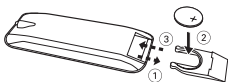
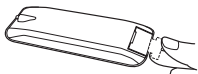

---

## Connect power



### Warning

- Risk of product damage! Ensure that the power supply voltage corresponds to the voltage printed on the back or the underside of the apparatus.
- Risk of electric shock! When you disconnect the AC power, always pull the plug from the socket. Never pull the cord.



### Note

- Install the apparatus near the power supply socket and where the power plug can be easily reached.

**1** Connect the AC power cord to the AC input jack on the apparatus and to the power supply socket.

- To switch the apparatus off completely, disconnect the AC power cord from the power supply socket.





## Note

- To save energy: after use, turn off the apparatus.

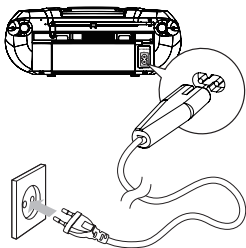

---

## Turn on

- 1 Press .  
↳ The unit switches to the last selected source.

# 4 Play

---

## Play CD

- 1 Press **CD** to select the disc source.
- 2 Press **OPEN•CLOSE** to open the disc tray.
- 3 Insert a disc with the printed side facing up, then close the disc tray.  
↳ Play starts automatically.
  - To pause/resume play, press .

- To stop play, press ■.
- For MP3/WMA files: to select an album, press ▲/▼.
- To skip to a track, press ◀/▶.
- To search within a track, press and hold ◀◀▶▶. Release to resume normal play.

---

## Play from USB devices



### Note

- Ensure that the USB device contains playable audio contents for supported formats.

- 1 Insert the USB connector on the device into the  socket.
- 2 Select **USB** source.
- 3 Press ▲/▼ unit to select a folder.
- 4 Press ◀/▶ to select a file.
- 5 Press ▶|| to start play.
  - To stop play, press ■.
  - To pause or resume play, press ▶||.

---

## Listen to an external device

You can listen to an MP3 player through this apparatus.

- 1 Use a cable with 3.5mm plugs on both ends (not supplied) to connect **MP3 LINK** jack (3.5mm) on this apparatus and the headphone jack on an MP3 player.

## 5 Play options

---

### Adjust volume level

- 1 During play, press **VOL +/-** to increase/decrease the volume level.
- 

### Select a preset sound effect

- 1 During play, press **DSC** repeatedly to select:
    - [POP] (pop)
    - [JAZZ] (jazz)
    - [CLASSIC] (classic)
    - [ROCK] (rock)
- 

### Enhance bass

- 1 During play, press **DBB** to turn on or off dynamic bass enhancement.  
↳ If DBB is activated, DBB is displayed.
- 

### Mute sound

- 1 During play, press **MUTE** to mute/unmute sound.
- 

### Select play modes



- 1 Press **MODE** repeatedly to select a play mode:
  - [↺] (repeat) – repeat a track
  - [↺ ALL] (repeat all) - repeat an entire CD/program
  - [↻] (shuffle) - play tracks randomly

-  (shuffle repeat all) - repeat all tracks randomly.

2 To return to normal play, press **MODE** repeatedly until play mode icons are no longer displayed.





Tip

- Only  and  can be selected when you play programmed tracks.

---

## Program tracks

You can program a maximum of 20 tracks.

- 1 In CD/USB mode, at the stop position, press **PROG** to activate the program mode.
  - ↳ [PROG] (program) starts to blink.
- 2 For MP3/WMA tracks, press **ALBUM/PRESET +/-** to select an album.
- 3 Press  to select a track number, then press **PROG** to confirm.
- 4 Repeat steps 2 to 3 to program more tracks.
- 5 Press  to play the programmed tracks.
  - ↳ During play, [PROG] (program) is displayed.
    - To erase the program, in the stop position, press .
    - To review the program, in the stop position, press and hold **PROG** for more than 2 seconds.

# 6 Listen to the radio

---

## Tune to a radio station



### Note

- For optimal reception, fully extend and adjust the position of the FM antenna.

- 1 Press **TUNER** to select FM or MW.
- 2 Press and hold **◀◀▶▶** for more than 2 seconds.
  - ↳ [SEARCH] (search) is displayed.
  - ↳ The radio tunes to a station with strong reception automatically.
- 3 Repeat step 2 to tune to more stations.
  - To tune to a weak station, press **◀◀▶▶** repeatedly until you find optimal reception.

---

## Program radio stations automatically



### Note

- You can program a maximum of 20 FM radio stations and 20 MW radio stations.

- 1 In tuner mode, press and hold **PROG** for 2 seconds to activate automatic program mode.
  - ↳ [AUTO STORE] (auto store) is displayed.

- ↳ All available stations are programmed in the order of waveband reception strength.
- ↳ The first programmed radio station is broadcast automatically.

---

## Program radio stations manually



### Note

- You can program a maximum of 20 FM radio stations and 20 MW radio stations.

- 1 Tune to a radio station.
- 2 Press **PROG** to activate program mode.
  - ↳ [PROG] (program) blinks on the display.
- 3 Press **▲▼** to allocate a number (1 to 20 for FM and 1 to 20 for MW) to this radio station, then press **PROG** to confirm.
  - ↳ The preset number and the frequency of the preset station are displayed.
- 4 Repeat the above steps to program other stations.



### Note

- To overwrite a programmed station, store another station in its place.

---

## Select a preset radio station

- 1 In tuner mode, press **▲▼** to select a preset number.

## 7 Other features

---

### Set the sleep timer

This unit can switch to standby automatically after a set period of time.

- 1 When the unit is turned on, press **SLEEP**  repeatedly to select a set period of time (in minutes).

↳ When sleep timer is activated, the display shows **z<sup>2</sup>**.

### To deactivate sleep timer

- 1 Press **SLEEP**  repeatedly until **[SLEEP OFF]** (sleep off) is displayed.

↳ When sleep timer is deactivated, **z<sup>2</sup>** disappears on the display.

---

## Turn on/off the screen backlight

To turn on/off the screen backlight of main unit,

- 1 Press and hold **SLEEP** .

## 8 Product information



### Note

- Product information is subject to change without prior notice.

---

# Specifications

---

## Disc

---

Laser Type	Semiconductor
Disc Diameter	12cm/8cm
Support Disc	CD-DA, CD-R, CD-RW, MP3-CD, WMA-CD
Audio DAC	24Bits / 44.1kHz
Total Harmonic Distortion	<1%
Frequency Response	60Hz -16kHz
S/N Ratio	>62dBA

---

## Tuner

---

Tuning Range	FM: 87.5 - 108MHz; MW: 531 - 1602kHz
Tuning grid	50 kHz (FM); 9 kHz (MW)
Total Harmonic Distortion	<3%
Signal to Noise Ratio	>50 dB

---

## General

---

Power supply	220-240V~, 50-60Hz; or DC 6X1.5V  / SIZE "D" / R20 CELL
Operation Power Consumption	10 W

---



---

Standby Power Consumption	<1 W
<hr/>	
Dimensions	
- Main Unit (W x H x D)	435 x 170 x 270mm
<hr/>	
Weight	2.79 kg
<hr/>	

---

## Supported MP3 disc formats

- ISO9660, Joliet
- Maximum title number: 512 (depending on file name length)
- Maximum album number: 255
- Supported sampling frequencies: 32 kHz, 44.1kHz, 48 kHz
- Supported Bit-rates: 32~256 (kbps), variable bit rates

---

## USB playability information

### Compatible USB devices:

- USB flash memory (USB 2.0 or USB1.1)
- USB flash players (USB 2.0 or USB1.1)
- memory cards (requires an additional card reader to work with this apparatus)

### Supported formats:

- USB or memory file format FAT12, FAT16, FAT32 (sector size: 512 bytes)
- MP3 bit rate (data rate): 32-320 Kbps and variable bit rate
- WMA v9 or earlier
- Directory nesting up to a maximum of 8 levels
- Number of albums/ folders: maximum 99
- Number of tracks/titles: maximum 999
- File name in Unicode UTF8 (maximum length: 128 bytes)

## Unsupported formats:

- Empty albums: an empty album is an album that does not contain MP3/WMA files, and is not be shown in the display.
  - Unsupported file formats are skipped. For example, Word documents (.doc) or MP3 files with extension .dlf are ignored and not played.
  - AAC, WAV, PCM audio files
  - DRM protected WMA files (.wav, .m4a, .m4p, .mp4, .aac)
  - WMA files in Lossless format
- 

## Maintenance

### Clean the cabinet

- Use a soft cloth slightly moistened with a mild detergent solution. Do not use a solution containing alcohol, spirits, ammonia or abrasives.

### Clean discs

- When a disc becomes dirty, clean it with a cleaning cloth. Wipe the disc from the centre out.
- Do not use solvents such as benzene, thinner, commercially available cleaners, or antistatic spray intended for analogue records.



### Clean the disc lens

- After prolonged use, dirt or dust may accumulate at the disc lens. To ensure good play quality, clean the disc lens with Philips CD lens cleaner or any commercially available cleaner. Follow the instructions supplied with cleaner.

# 9 Troubleshooting



## Warning

- Never remove the casing of this apparatus.

To keep the warranty valid, never try to repair the system yourself. If you encounter problems when using this apparatus, check the following points before requesting service. If the problem remains unsolved, go to the Philips web site ([www.Philips.com/support](http://www.Philips.com/support)), or contact Philips (see Contact information). When you contact Philips, ensure that the apparatus is nearby and the model number and serial number are available.

### No power

- Ensure that the Mains cord is connected securely.
- Ensure that there is power at the AC Mains.
- Ensure that the batteries are inserted correctly.

### No sound or poor sound

- Adjust the volume.

### No response from the unit

- Disconnect and reconnect the AC power plug, then turn on the system again.
- As a power-saving feature, the unit switches off automatically 15 minutes after track play reaches the end and no control is operated.

### Remote control does not work

- Before you press any function button, first select the correct source with the remote control instead of the main unit.

- Reduce the distance between the remote control and the unit.
- Insert the battery with its polarities (+/- signs) aligned as indicated.
- Replace the battery.
- Aim the remote control directly at the sensor on the front of the unit.

### **USB device not supported**

- The USB device is incompatible with the apparatus. Try another one.

### **No disc detected**

- Insert a disc.
- Check if the disc is inserted upside down.
- Wait until the moisture condensation at the lens has cleared.
- Replace or clean the disc.
- Use a finalized CD or correct format disc.

### **Poor radio reception**

- Increase the distance between the unit and your TV or VCR.
- Fully extend the FM antenna.
- Connect an outdoor FM antenna instead.



© 2010 Koninklijke Philips Electronics N.V.

All rights reserved.

AZ1850\_12\_UM\_V2.0

